

Universal 16 channel I/O CANx extension

ENG - Data sheet

Issue date 26.11.2021

Application

Universal 16 channel IO device is designed to be used in building automation applications as an extension module to LogicMachine series devices based on CAN FT bus. The configuration and monitoring of the device is done through separate LogicMachine canX application. The device is designed for DIN-rail mounting and requires 4 DIN-units.



Types of product

CAN-UIO16 Universal CANx bus IO module 16 AI/DO

Standards and norms compliance

CE conformity: EMBS-CE-190223/02 Electromagnetic compatibility

EMC: EN61000-6-1
EN61000-6-3

PCT Certificate

Technical data:

Power supply: 12-32 VDC

Power consumption (at 24 V) 12 mA

Protection: ± 50 V

Wrong wiring polarity protection

Interface:	Universal Inputs/Outputs	16
	Analog input resolution	12bits
	Digital output current	350 mA (max 2 A per whole device)
	CAN FT	1
Clamps:	CAN FT	CAN FT Connection Terminal
		0.8mm ²
	Inputs/Outputs	3.5mm ²
	Power supply	5 mm ²
Enclosure:	Material:	Polyamide
	Color:	Gray
	Dimensions:	52(W)x100(H)x56(L) mm
Protection:	IP20 according to EN 60529	
Usage temperature:	-5C ... +55C	
Storage temperature:	-20C ... +70C	
Net weight:	80g	
Gross weight:	94g	



Caution

Security advice

The installation and assembly of electrical equipment may only be performed by skilled electrician. The devices must not be used in any relation with equipment that supports, directly or indirectly, human health or life or with application that can result danger of people, animals or real value

Mounting advice

The devices are supplied in operational status. The cables connections included can be clamped to the housing if required.

Electrical connection

The devices are constructed for the operation of protective low voltage (SELV). Grounding of device not needed. When switching the power supply on or off, power surges must be avoided.

Default settings

Line ID: 0

Node ID: 1

Max. number of group addresses per object : 16

Reset to defaults

Press programming button for 5 seconds, the RED LED blinks 2 times, then release button - GREEN lights up shortly.

Programming physical address

Press *Tools* → *Write device address* from CANx app. Choose address and press *Write*. Then press programming button shortly on the device, GREEN LED lights up shortly. The LED is switched off automatically in 1 second which means address is written.

1. Connection diagrams

CAN FT connection

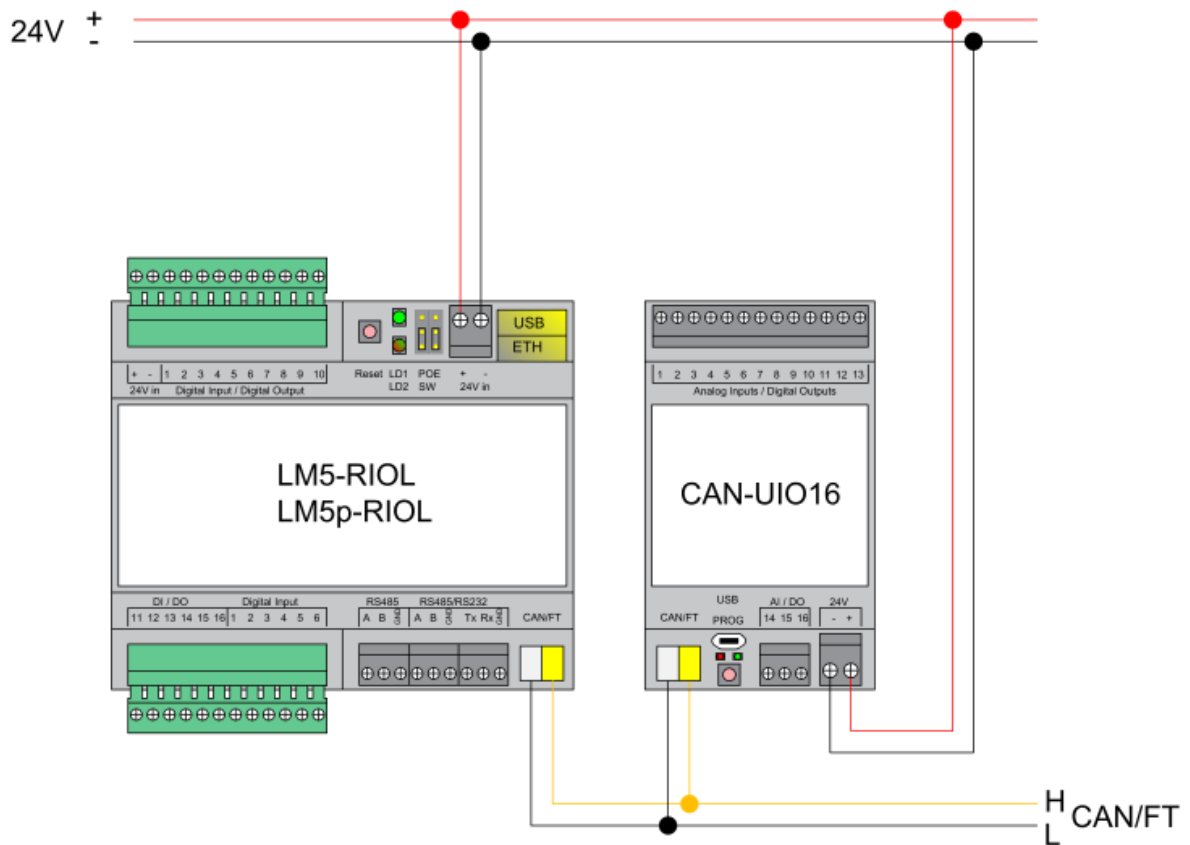

Digital / Analog input

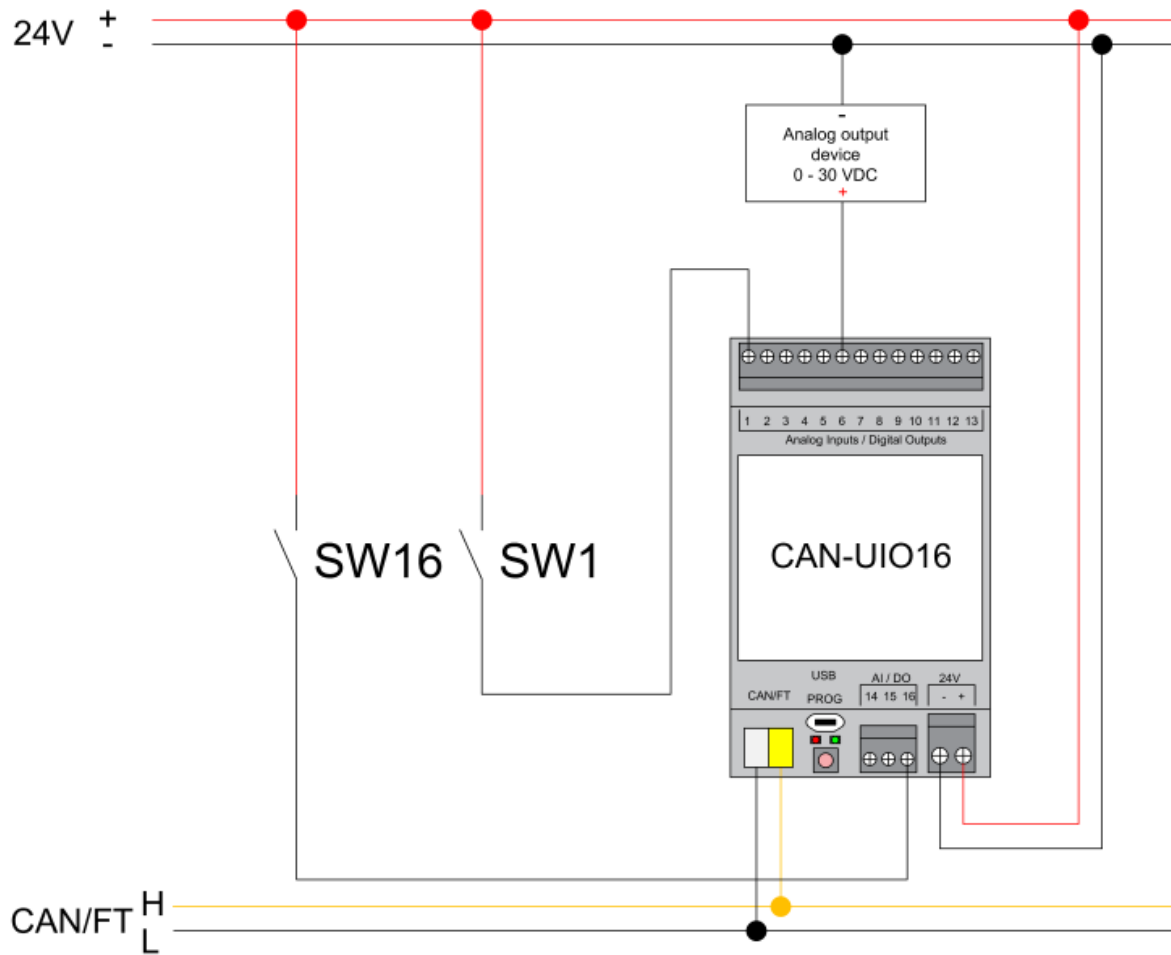

Digital output (e.g. external contactor control)

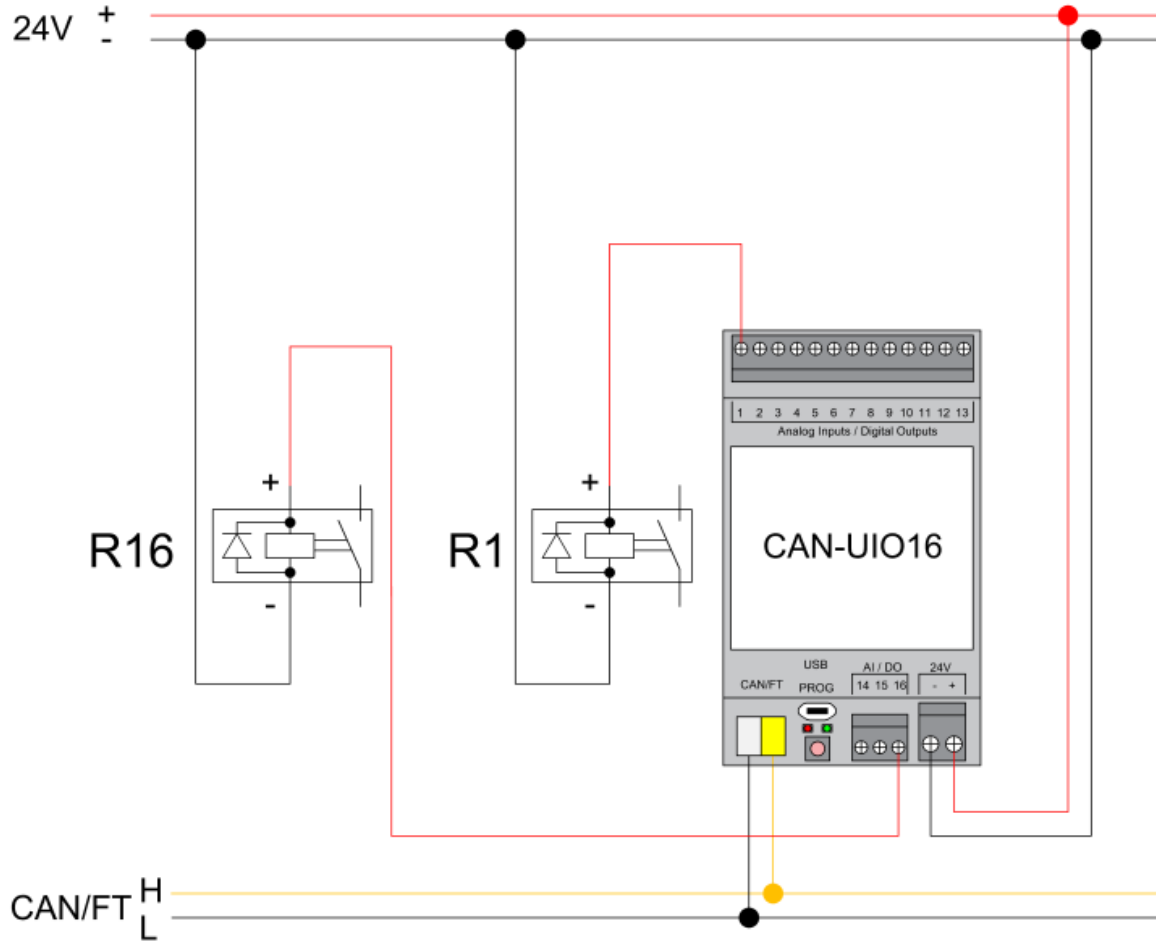

2. canX software settings

2.1. Digital output

UIO16 (16 Universal IO ports) (0.1) x

All Enabled Disabled

Output 1 ⊖ Output status 1 ⊖ Input 1 ⊖

Port 1 **Port 1**
Port 2
Port 3
Port 4
Port 5
Port 6
Port 7
Port 8
Port 9
Port 10
Port 11
Port 12
Port 13
Port 14
Port 15
Port 16

Output 1

Normal - Off after power-up
Disabled
Normal - Off after power-up
Inverse - Off after power-up
Normal - On after power-up
Inverse - On after power-up

Flags

F T R W

Tags

Q No tags set

Save and write to device Save Cancel

Default flags: read (R), write (W), transmit (T)

Output mode:

Normal – Off after power-up

Inverse – Off after power-up

Normal – On after power-up

Inverse – On after power-up

Group addresses – you can assign group addresses from the predefined list or add manually by clicking on ADD button. You can assign max 16 group addresses to one object / output.

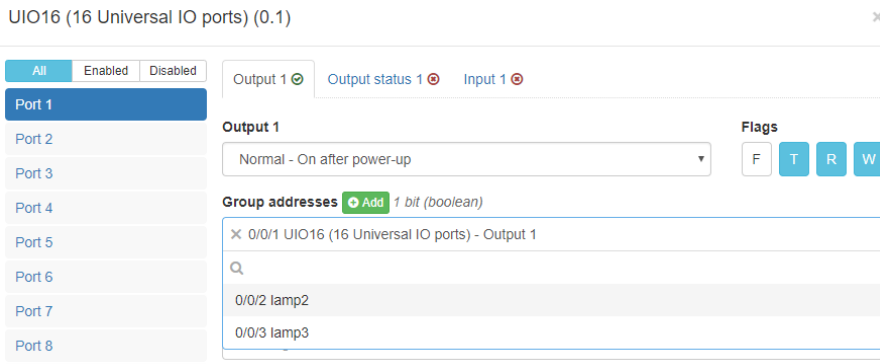

2.2. Digital output status

Status (response after read command) will return a real measurement value (1 – for high voltage, 0 – for no voltage)

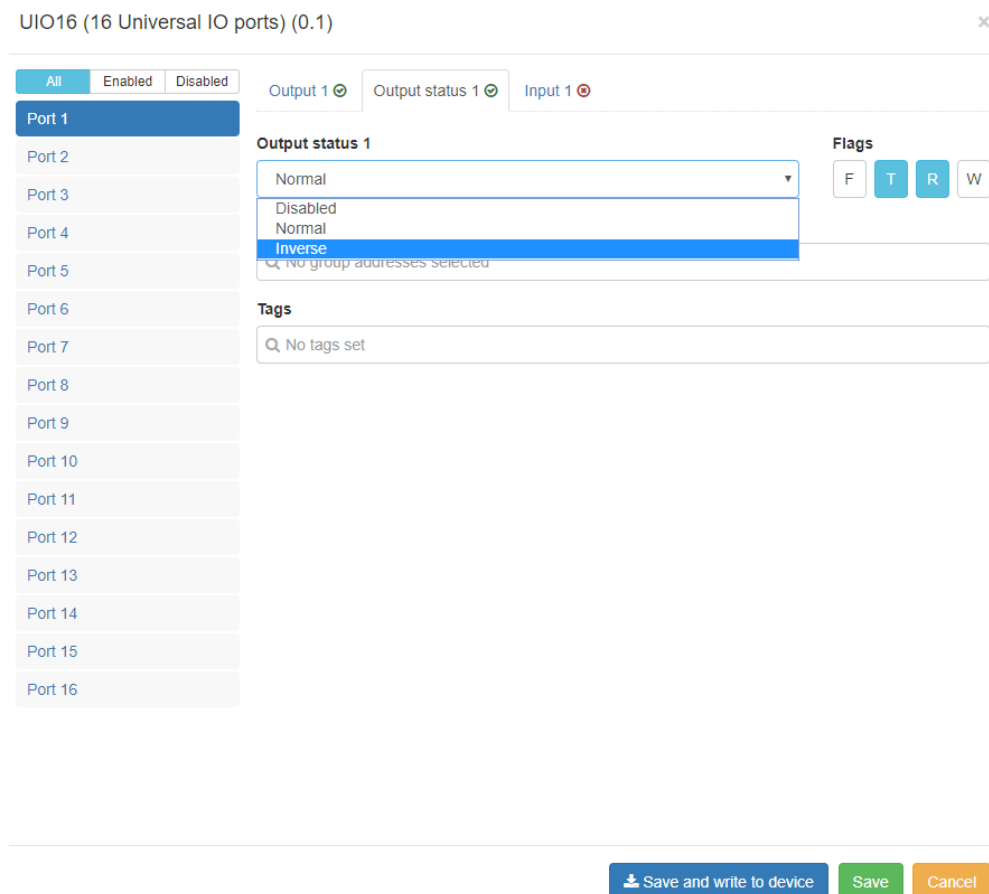

Default flags: read (R), transmit (T)

Output status: Disabled, Normal, Inverse

Group addresses – you can assign group addresses from the predefined list or add manually by clicking on ADD button. You can assign max 16 group addresses to one object / output status

2.3. Input mode

UIO16 (16 Universal IO ports) (0.1) x

All Enabled Disabled Output 1 ⊖ Output status 1 ⊖ Input 1 ⊕

Port 1 (selected)

Port 2
Port 3
Port 4
Port 5
Port 6
Port 7
Port 8
Port 9
Port 10
Port 11
Port 12
Port 13
Port 14
Port 15
Port 16

Input 1

Switch - On/Off
Disabled
Switch - On/Off
Switch - Off/On (inverse)
Switch - Toggle
Button - Toggle (optional long press)
Button - On (optional long press)
Button - Off (optional long press)
Button - Start/Stop
Button - Stop/Start (inverse)

Flags

F T R W

Save and write to device Save Cancel

Default flags: read (R), write (W), transmit (T)

Input mode:

Switch on/off – send 1 to bus if switched ON or 0 if switched OFF

Switch off/on (inverse) – send 0 to bus if switched ON or 1 if switched OFF

Switch Toggle - change status to inverted with every push



Button Toggle (optional long press) – change status to inverted with every push
Button On (optional long press) – push 1 to bus every pulse
Button Off (optional long press) – push 0 to bus every pulse

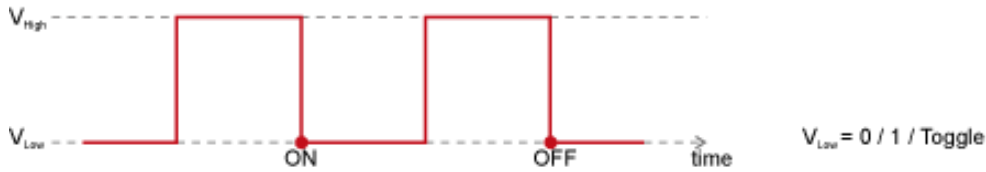

Button Start/Stop – send 1 when pushed and 0 when released
Button Stop/Start (inverse) – send 0 when pushed and 1 when released

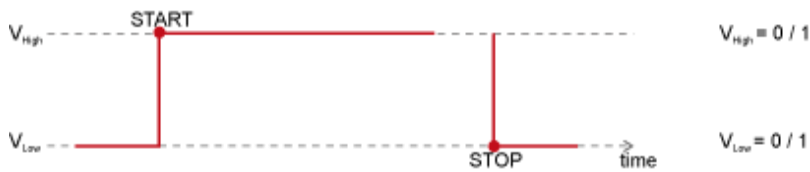

Button long press toggle - Send 0 or 1 to bus with every long press
Button long press send 1 - Send 1 with every long press
Button long press send 0 - Send 0 with every long press



UIO16 (16 Universal IO ports) (0.1)

Output 1 Output status 1 Input 1 Input 1 - Long press

Input 1 - Long press
 Disabled
 Disabled
 Long press - Toggle
 Long press - On
 Long press - Off